

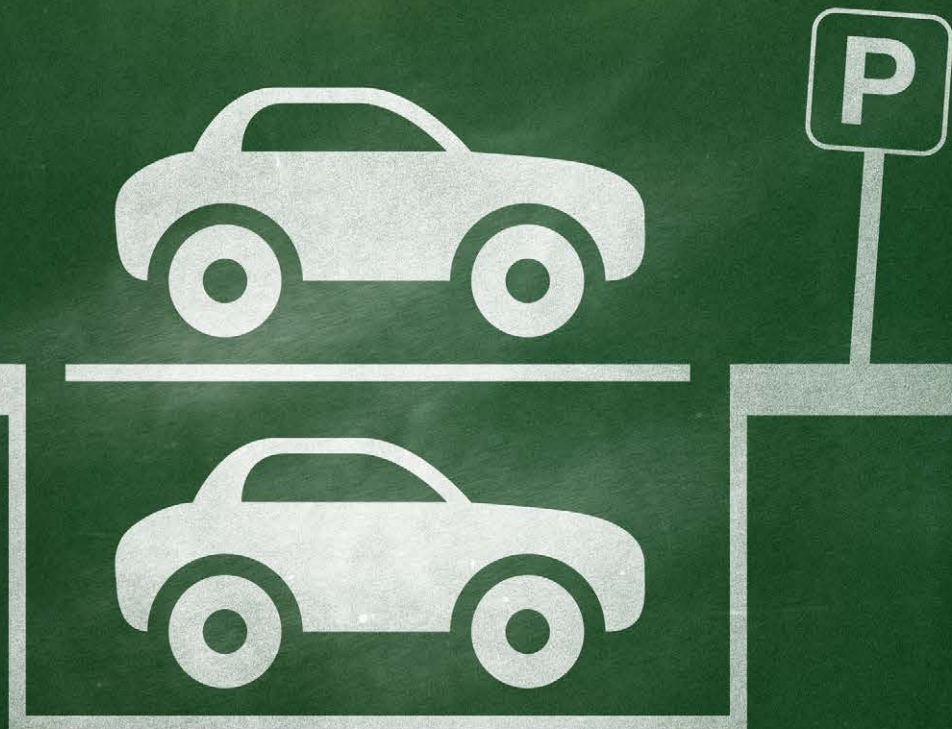

HERE IS YOUR NEW PARKING SPACE/GARAGE



WATCH THE VIDEO

.....
Scan the code and see how it works



SAVE TIME AND FREE UP SPACE

.....
You're saving time and freeing up space while our car is safe underground

STORAGE

.....
Keep your classic car close by or your sports car safe

PRICE

.....
Cheaper than a traditional garage

NO STRESS

.....
Don't waste time looking for a parking space – you have your own

OUTSIDE YOUR FRONT DOOR

.....
Narrow streets – not a problem

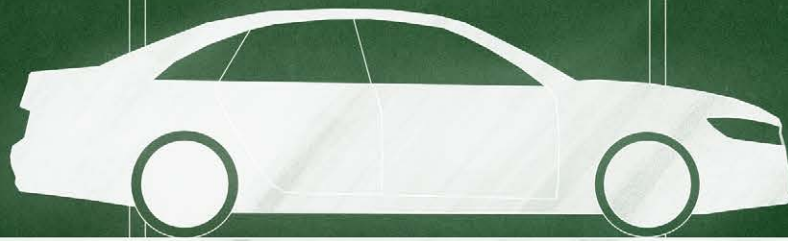
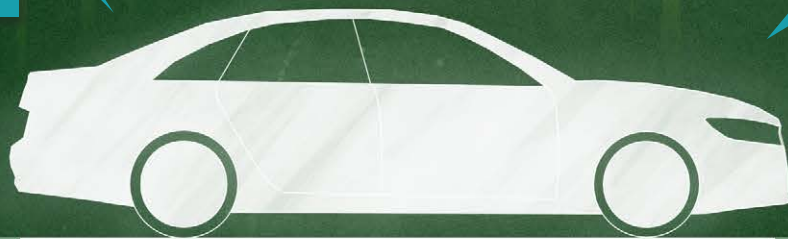

NO PROPERTY TAX

.....
Not a part of the allowed building size – and no property tax

WINTER

.....
No more scraping ice in the morning

INSTALLATION

.....
Your parking space can be ready in no time – some projects take less than a week

ENVIRONMENTALLY FRIENDLY

.....
Pump runs of water – no risk of oilspills

THEFT AND VANDALISM

.....
Save money and stop worrying – Only you can operate the Car-pit

CAR-PIT SAVES TIME AND FREES UP SPACE

Employees having problems finding a parking space when coming in for work? Your driveway too small? Worried about your car getting stolen? Subnovates parking unit solves these problems. With Subnovate you can park your cars underground, which frees up that extra space. This way you can park your car close to work or home. You're saving time and freeing up space while your car is safe underground.

The multi-parking system with two parking spaces (One on top of the other) as a 1+1 solution. Environmentally friendly water driven hydraulics ensures smooth elevation of the parking spaces. Operated by key or remote control. Easy and simple like an elevator.

The car is parked on the platform like in a carwash. External safety grates makes sure the car is kept steady while the elevator is moving.

The surface of the topmost parking space can be made to match the surroundings. Cobblestones, concrete tiles, asphalt, grass and more. As long as the weight doesn't exceed 250 kg/m² which is the weight of cobblestones.

We can deliver quickly – and we take care of digging, casting and installation.

Concrete construction

The concrete construction is done in reinforced concrete. We install a submersible pump with an alarm in the pit. This leads the water into existing drainage systems. The outside of the pit is waterproof.

If you don't want to keep the excavated dirt, we can get rid of it for you.

Contact us for prices on surfacing.

As our customer, you can also do the digging or other parts of the construction work yourself. Contact us to find the solution that suits you.

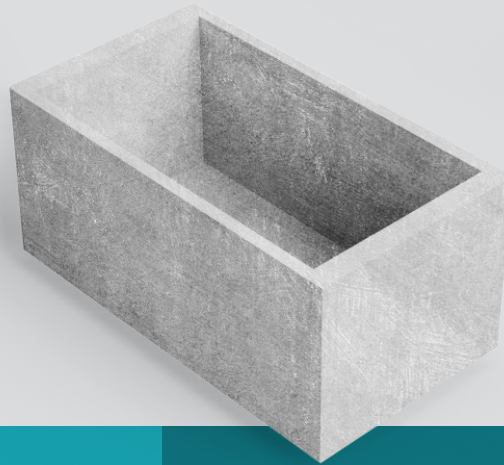

CAR-PIT:

- 1 water hydraulic lifting system.
- 4 telescopic columns with built-in stop-system and drop protection fixed into the concrete floor
- Wire stabilizing system ensures the platforms are always level.
- 1 upper platform – no coating.
- 1 lower platform – grating or droplet shaped checker plate
- Bolts, screws, electrical valves, electro-magnets and assembling parts
- All steel parts are galvanized

Load

	Standard
Lower platform:	2000 kg. max.
Upper platform:	2000 kg. max.
Snow:	75 kg/m ² (Danish average)

Measurements

Lower platform:	2500 x 5000 mm
Upper platform:	2000 x 4500 mm
Lift height:	1900 mm
Clearance:	1700 mm

INSTALLATION

SUBNOVATEs electrical system must be installed according to the included electrical schematics. 380 Volts, 3 phased 0, grounded with 20A fuses. The system consumes 7.5 kW.

Ventilation

Special needs for air circulation such as ventilation, heat and climate control are optional extras. Reduce humidity and moisture around your car. (Rain, snow, ice etc.)

Maintenance

The moving parts should be serviced at least once a year, and at the same time visual inspection of joints, weldings etc. is required. First service (12 months after installation) is conducted by Subnovate – subsequently Subnovate offers a service agreement.

Quality control

The Car-pit is CE Marked according to Maskindi- rektivet 2006/42/EF and subsequently checked by Teknologisk Institut.

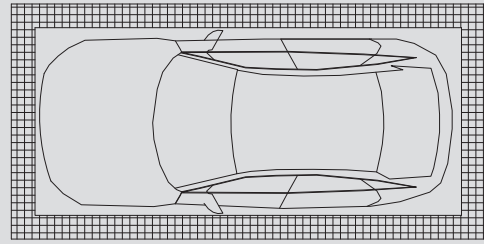

Floor plan

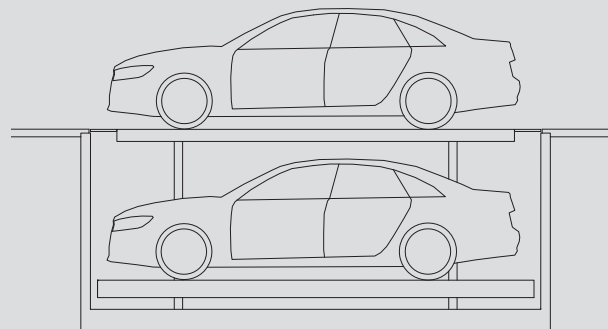

Schematics

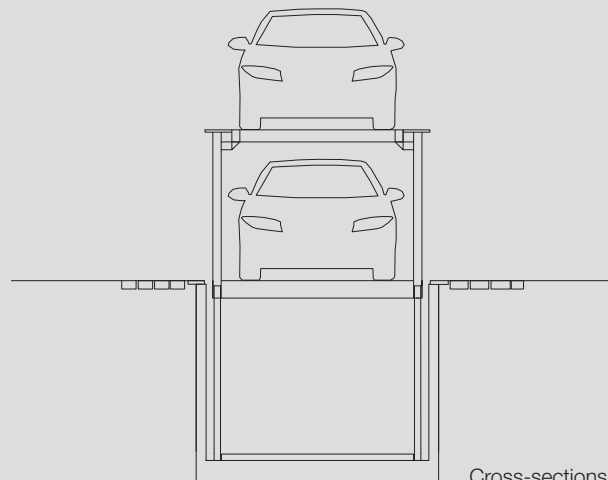

Cross-sections

PLEASE CONTACT US WITH ANY IDEAS – WE’RE ALWAYS READY FOR SOME BRAINSTORMING AND A CUP OF TEA OR COFFEE

Subnovate works to make everyday life easier through innovation. We aim to seek out new and better ways of thinking storage and how to maximize the use of space.

We use the term “SUB”, as we are working in submerged storage. Our lift systems make the garbage “disappear” and we can drastically reduce cost and workhours by using our very own, special excavation techniques.

SUBNOVATE ApS

Værkmestergade 25, 9. sal

DK-8000 Aarhus

/ T [+45] 8676 6196

/ E info@subnovate.com

/ W subnovate.com